

YAMAHA CDC-35 *RS*

Natural Sound Compact Disc Player

Auto changer Mechanism with 10-Disc Magazine

Hi-Speed D/A Converter

36-Track Random Access Programmable Playback

Direct Disc/Track Play, Index Search

Plus one play

Full, Disc and Single Repeat Play

Disc/Music Scan

Remote Control Operation

Thank you for purchasing the YAMAHA Compact Disc Player CDC-35.

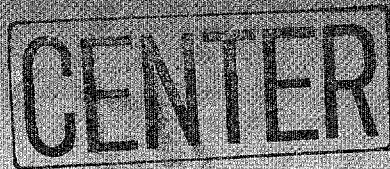

CONTENTS

Safety Instructions	1	Search Operation	17
Caution	2	Scan Function	19
Caution Labels	3	Random Play	19
Removing the Transportation Screws	3	Program Play	20
Notes on Handling the Discs and Magazine	4	Repeat Play	22
Controls and Functions	7	Plus One Play	23
Using the Remote Control Transmitter	11	Timer Play	23
Connections	14	Memory Backup	24
Magazine Loading	15	Specifications	24
Disc Play	15	Troubleshooting	25
Direct Play	16		

OWNER'S MANUAL

IMPORTANT!

Please record the serial number of your unit in the space below.

Model: **CDC-35**

Serial No.:

The serial number is located on the rear of the unit.

Retain this Owner's Manual in a safe place for future reference.

SAFETY INSTRUCTIONS

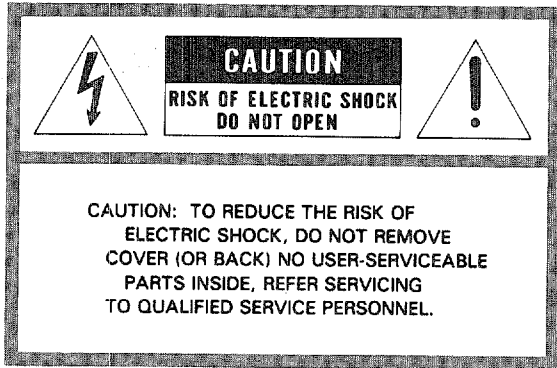

• Explanation of Graphical Symbols

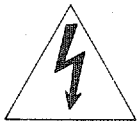

The lightning flash with arrowhead symbol, within an equilateral triangle, is intended to alert you to the presence of uninsulated "dangerous voltage" within the product's enclosure that may be of sufficient magnitude to constitute a risk of electric shock to persons.

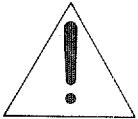

The exclamation point within an equilateral triangle is intended to alert you to the presence of important operating and maintenance (servicing) instructions in the literature accompanying the appliance.

WARNING

To prevent fire or shock hazard, do not expose this appliance to rain or moisture.

- 1 Read Instructions** — All the safety and operating instructions should be read before the appliance is operated.
- 2 Retain Instructions** — The safety and operating instructions should be retained for future reference.
- 3 Heed Warnings** — All warnings on the appliance and in the operating instructions should be adhered to.
- 4 Follow Instructions** — All operating and other instructions should be followed.
- 5 Water and Moisture** — The appliance should not be used near water — for example, near a bathtub, washbowl, kitchen sink, laundry tub, in a wet basement, or near a swimming pool, etc.
- 6 Carts and Stands** — This appliance should be used only with a cart or stand that is recommended by the manufacturer.
- 7 Wall or Ceiling Mounting** — The appliance should be mounted to a wall or ceiling only as recommended by the manufacturer.
- 8 Ventilation** — The appliance should be situated so that its location or position does not interfere with its proper ventilation. For example, the appliance should not be situated on a bed, sofa, rug, or similar surface, that may block the ventilation openings; or cabinet that may impede the flow of air through the ventilation openings.
- 9 Heat** — The appliance should be situated away from heat sources such as radiators, stoves, or other appliances that produce heat.
- 10 Power Sources** — The appliance should be connected to a power supply only of the type described in operating instructions or as marked on the appliance.
- 11 Power-Cord Protection** — Power-supply cords should be routed so that they are not likely to be walked on or pinched by items placed upon or against them, paying particular attention to cords at plugs, convenience receptacles, and the point where they exit from the appliance.
- 12 Cleaning** — The appliance should be cleaned only as recommended by the manufacturer.
- 13 Nonuse Periods** — The power cord of the appliance should be unplugged from the outlet when left unused for a long period of time.
- 14 Object and Liquid Entry** — Care should be taken so that objects do not fall into and liquids are not spilled into the inside of the appliance.

CAUTION: READ THIS BEFORE OPERATING YOUR UNIT

15 Damage Requiring Service — The appliance should be serviced by qualified service personnel when:

- A. The power-supply cord or the plug has been damaged; or
- B. Objects have fallen, or liquid has been spilled into the appliance; or
- C. The appliance has been exposed to rain; or
- D. The appliance does not appear to operate normally or exhibits a marked change in performance; or
- E. The appliance has been dropped, or the cabinet damaged.

16 Servicing — The user should not attempt to service the appliance beyond those means described in the operating instructions. All other servicing should be referred to qualified service personnel.

17 Power Lines — an outdoor antenna should be located away from power lines.

18 Grounding or Polarization — The precautions that should be taken so that the grounding or polarization of an appliance is not defeated.

1 To ensure the finest performance, please read this manual carefully. Keep it in a safe place for future reference.

2 Install your unit in a cool, dry, clean place — away from windows, heat sources, and too much vibration, dust, moisture or cold. Avoid sources of hum (transformers, motors). To prevent fire or electrical shock, do not expose to rain and water.

3 Do not operate the unit upside-down. It may overheat, possibly causing damage.

4 Never open the cabinet. If a foreign object drops into the set, contact your dealer.

5 Do not place records or other objects on top of the unit; this will block the ventilation holes, cause the internal temperature to rise and may result in a failure.

6 Do not use force on switches, knobs or cords. When moving the set, first turn the unit off. Then gently disconnect the power plug and the cords connecting to other equipment. Never pull the cord itself.

7 Do not attempt to clean the unit with chemical solvents; this might damage the finish. Use a clean, dry cloth.

8 Be sure to read the "Troubleshooting" section on common operating errors before concluding that your unit is faulty.

9 This equipment generates and uses radio frequency energy and if not installed and used properly, that is, in strict accordance with the manufacturer's instructions, may cause interference to radio and television reception. It has been type tested and found to comply with the limits for a Class B computing device in accordance with the specifications in Subpart J of Part 15 of FCC Rules, which are designed to provide reasonable protection against such interference in a residential installation. However, there is no guarantee that interference will not occur in a particular installation. If this equipment does cause interference to radio or television reception, which can be determined by turning the equipment off and on, the user is encouraged to try to correct the interference by one or more of the following measures:

- Reorient the receiving antenna
- Relocate the CDC-35 with respect to the receiver
- Move the CDC-35 away from the receiver
- Plug the CDC-35 into a different outlet so that the CDC-35 and receiver are on different branch circuits.

If necessary, the user, should consult the dealer or an experienced radio/television technician for additional suggestions. The user may find the following booklet prepared by the Federal Communications Commission helpful: "How to Identify and Resolve Radio-TV Interference Problems".

This booklet is available from the U.S. Government Printing Office, Washington, DC 20402, Stock No. 004-000-00345-4.

CAUTION LABELS

CAUTION — USE OF CONTROLS, ADJUSTMENTS, OR PERFORMANCE OF PROCEDURES OTHER THAN THOSE SPECIFIED HEREIN, MAY RESULT IN HAZARDOUS RADIATION EXPOSURE.

THE UNIT SHOULD NOT BE ADJUSTED OR REPAIRED BY ANYONE EXCEPT PROPERLY QUALIFIED SERVICE PERSONNEL.

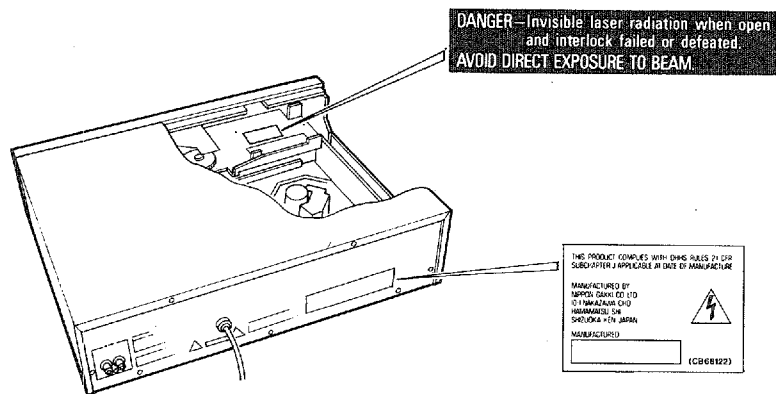

REMOVING THE TRANSPORTATION SCREWS

In order to protect the internal laser pickup from the vibration and shocks which occur during transportation, it is held in place with transportation screws located on the bottom of the unit. Be sure to remove the 4 transportation screws before making any connection.

1. As shown in the figure, spread out a soft cloth or other protective material, and gently stand the unit on its side, taking care not scratch the finish.
2. Remove the 4 transportation screws with a phillips (+) screwdriver.

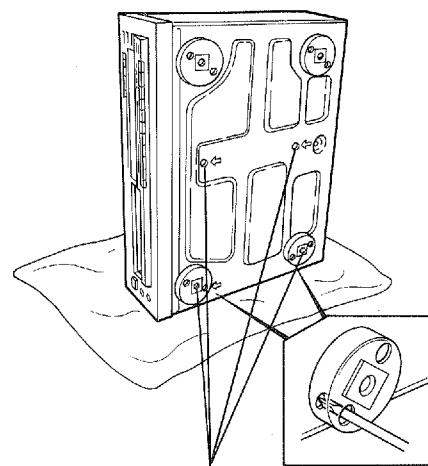

Transportation screws

- * To remove the screws, be sure to stand the unit on its side. Do not place it with the front facing up (rear panel terminals down).
- * After removing the screws, retain them in a safe place. When the unit is to be transported again, be sure to place the 4 screws to their original position.

NOTES ON HANDLING THE DISCS AND MAGAZINE

Notes on handling disc

- Your unit has been specifically designed for the reproduction of compact discs bearing the "disc" mark. No other discs should be loaded into the player.
- To remove a disc from its storage case, press down on the center of the opened case and lift the disc out carefully, holding it by the edges.

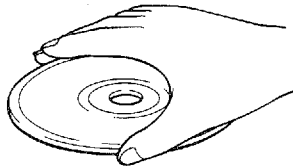
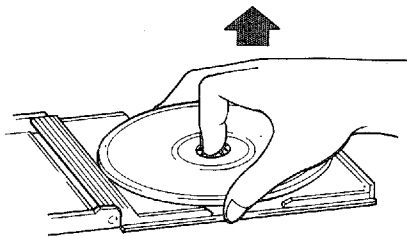

- Although compact discs are impervious to wear during play, damage to the surface of a disc through improper handling will result in play irregularities.

- Although minute dust particles and finger prints should have no effect on play, you should keep the recorded side surface of your discs clean by wiping them with a clean, dry cloth. Wipe in a straight motion from the inside to the outside. Do not wipe in a circular motion.

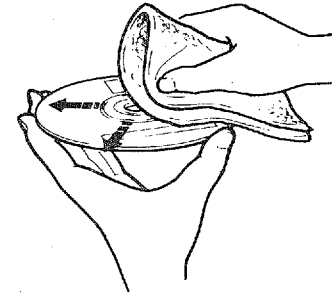

- Never use record cleaner, record spray, antistatic sprays or liquids, or any chemical-based liquid to clean the surface of a disc as these may irreparably damage the disc's plastic case.
- Avoid exposing discs to direct sunlight, high temperature, or high humidity for extended periods of time. Long exposure to high temperatures may warp a disc.



- Carefully handle the compact disc so that its surface is not scratched.

How to load discs into the magazine

1. The magazine disc trays are removable. Hold and pull on the right hand knobs to slide out the odd-numbered disc trays, and pull on the left hand knobs to slide out the even-numbered disc trays.

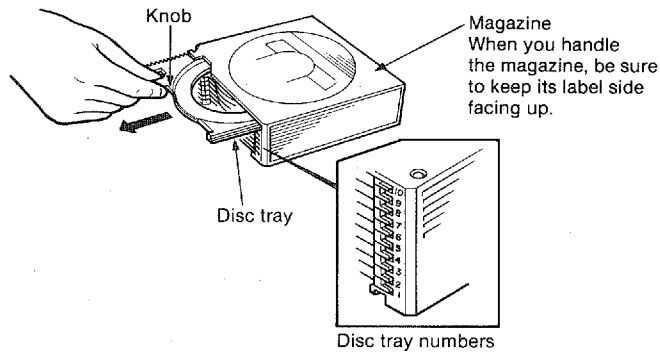

2. Draw the disc tray completely out of the magazine and place a Compact Disc on it with its label surface facing down.

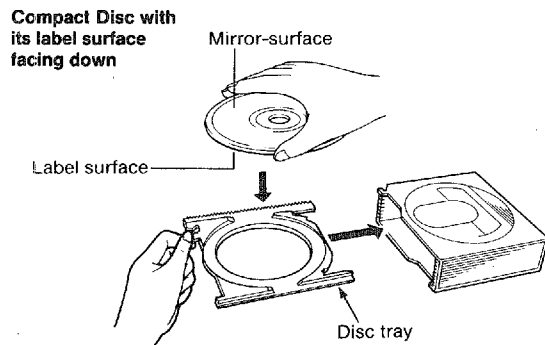

3. Line the disc tray up with the grooves in the magazine, and holding it by the knob, push the disc tray all the way in, until the tray clicks.

How to load the magazine

1. Insert the magazine loaded with discs into the magazine insertion slot, and then push on the center of the magazine until the magazine clicks into place.

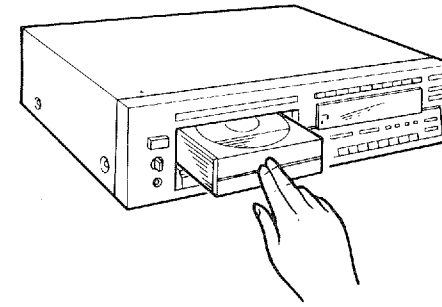

How to remove the magazine

1. Press the EJECT button when the power is turned on. The magazine is ejected and about 1/3 of the magazine will protrude from the player's front panel.
2. Remove the magazine with your hand.

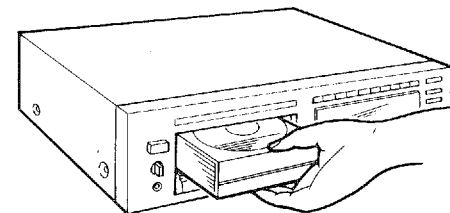

Notes on the magazine

- Since the disc trays can be removed from the magazine, be sure to keep the magazine horizontal, so as not to drop the discs or the disc trays.
- When putting a disc tray into the magazine, insert it between the left and right internal grooves of the magazine, and then push it in all the way so that the disc tray is secured horizontally. If a disc tray is inserted on a slant, using the incorrect grooves, the disc tray cannot be pushed all the way in, and this could cause trouble. Make sure that the disc trays are correctly inserted into the magazine.

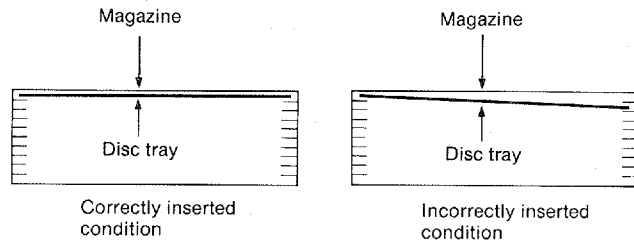

- Do not insert a disc into the magazine without first loading it onto a disc tray.
Be sure that the discs are loaded on the disc trays and inserted into the magazine correctly.
- After playing, the discs can be stored loaded in the magazine. When storing, do not store the magazine in a place exposed to direct sunlight or subject to high temperature.
- Be careful not to drop the magazine or subject it to shock.
Also do not apply intensive shock to the disc trays when they are removed from the magazine.
- Do not allow the magazine or disc tray to come into contact with benzine, thinner or any detergent solvent, for this may damage the surface finish.
- This unit is not designed for 8 cm sized Compact Discs.
Do not load an 8 cm sized Compact Disc with its adapter.

CONTROLS AND FUNCTIONS

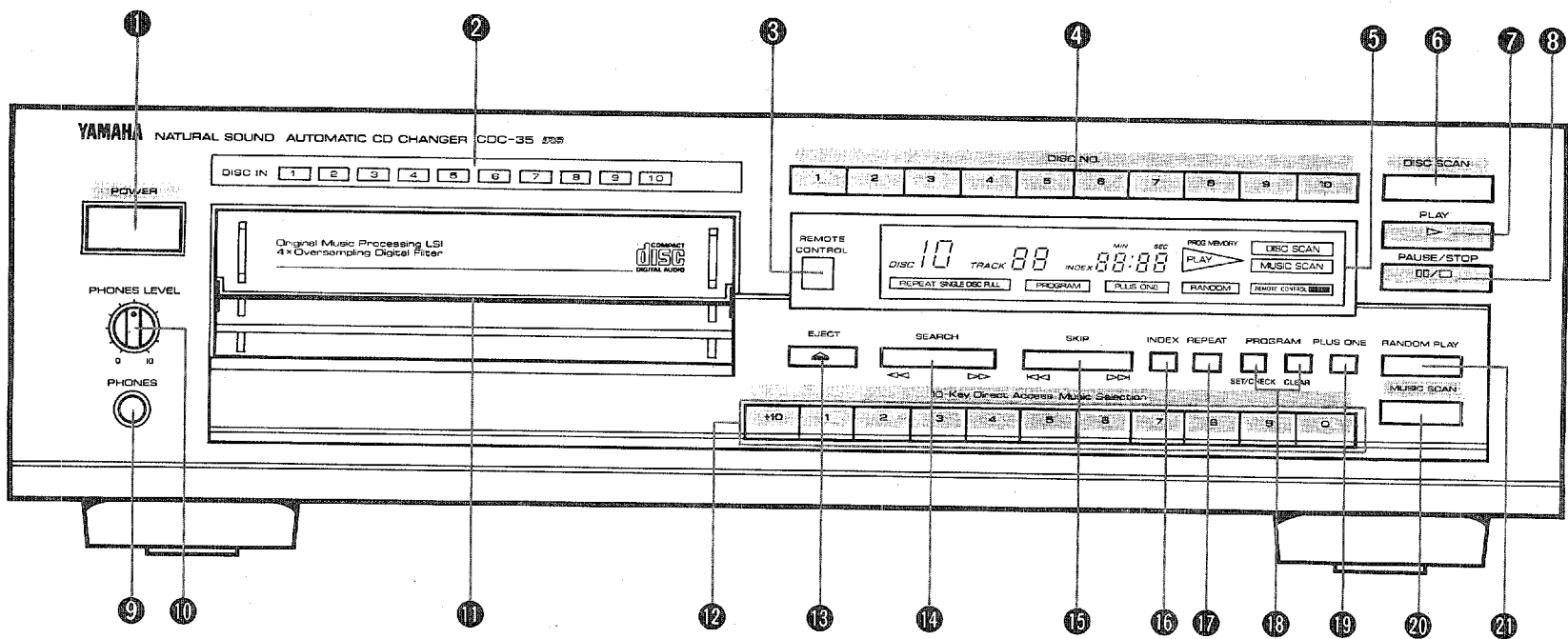

5 Display window

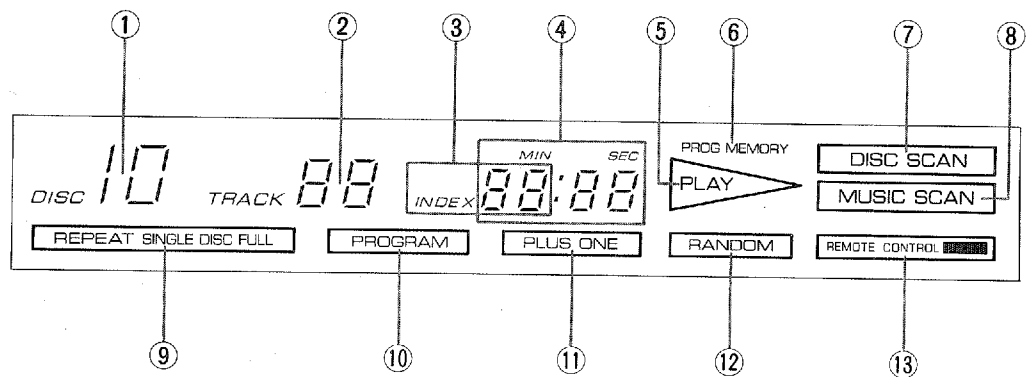

FRONT PANEL

① POWER switch

Press this switch to turn the power on. Press it again to turn the power off.

② DISC IN indicators

These indicators correspond to the number of each disc tray, and show that a disc has been placed on that tray.

③ REMOTE CONTROL sensor

Receives the signal from the remote control transmitter.

④ DISC NO. buttons

These buttons are pressed to select the disc to be played.

⑤ Display window

① DISC number display

Displays the number of the disc which is playing, or the number of the selected disc.

When a disc magazine has not been loaded, the DISC number shows 0, or else the first programmed disc number for a stored program.

② TRACK number display

Displays the track number of a disc.

When a disc magazine has not been loaded, the TRACK number shows 00, or else first programmed tune number for a stored program.

③ INDEX number display

During play or pause mode, displays the index number selected with the SKIP or numeric buttons.

④ Elapsed time/Program number display

Elapsed time:

Displays the elapsed time of the tune being played.

Program number:

Displays the program number.

⑤ PLAY indicator

This indicator lights during play, and blinks when the unit is set to pause mode.

⑥ PROGRAM MEMORY indicator

This indicator lights when the PROGRAM SET/CHECK button is pressed for programming. In any mode, once a program has been stored, this indicator remains lit.

⑦ DISC SCAN indicator

This indicator lights when the unit is in Disc Scan mode. In this mode, the beginning of each disc is played for about 10 seconds.

⑧ MUSIC SCAN indicator

This indicator lights when the unit is in Music Scan mode. In this mode, the beginning of each tune is played for about 10 seconds.

⑨ REPEAT SINGLE/DISC/FULL indicators

These indicators show repeat play mode.

REPEAT SINGLE:

One tune is played repeatedly.

REPEAT DISC:

All the tunes on a disc are played repeatedly.

REPEAT FULL:

The tunes on all of the discs are played repeatedly.

⑩ PROGRAM indicator

This indicator shows that the program memory is active.

⑪ PLUS ONE indicator

Lights to show that the unit is in Plus One mode. A desired tune will be played after playing the current tune.

⑫ RANDOM indicator

This indicator lights when Random Play mode is engaged. The disc order and tune order are automatically rearranged so that the tunes are played at random.

⑬ REMOTE CONTROL indicator

This indicator lights when the REMOTE CONTROL sensor receives a signal from the remote control transmitter.

⑥ DISC SCAN button

Press this button to play the beginning of each disc for about 10 seconds.

⑦ PLAY button

Press this button to begin play.

⑧ PAUSE/STOP button

When this button is pressed during play, the PLAY indicator starts to blink and play is temporarily stopped. To resume play at the point where it was paused, press the PLAY button.

In pause mode, pressing this button stops the unit at the beginning of the disc for normal play. When the magazine contains more than 1 disc, the unit stops at the beginning of the first disc.

For programmed tune play, the unit stops at the beginning of the first programmed tune.

For programmed disc play, the unit stops at the beginning of the first programmed disc.

⑨ PHONES jack

Connect the headphones plug into this jack for private listening.

⑩ PHONES LEVEL control

Use this control to adjust the level at the PHONES jack.

⑪ Magazine slot

Insert the 10-disc magazine into this slot.

⑫ Numeric buttons (+10, 1-0)

Use these buttons to designate the track number or index number when selecting tunes.

For full detail on the numeric buttons, refer to the Numeric Button Operation section described later.

13 EJECT button

Press this button to eject the magazine pack.

14 SEARCH button

During play, press the ►► side of this button to play the disc in forward at high speed, press the ◀◀ side of this button to play the disc in reverse at high speed.

15 SKIP button

During play, press this button to skip to a desired tune. This button is also used to select an index number.

16 INDEX button

When this button is pressed, an index number can be selected with the numeric or SKIP buttons.

17 REPEAT button

Press this button to select repeat play mode, from SINGLE, DISC, FULL, and repeat-off.

18 PROGRAM buttons

SET/CHECK:

Use this button to enter something into the program memory, or to check the program contents.

CLEAR:

Press this button to clear the program content.

19 PLUS ONE button

Use this button to insert a tune during play. When that tune has been played, the unit returns to the original play mode.

20 MUSIC SCAN button

Press this button to play approximately the first 10 seconds of each tune on all of the discs.

21 RANDOM PLAY button

When this button is pressed, the disc order and tune order are rearranged automatically, and the tunes will be played at random.

USING THE REMOTE CONTROL TRANSMITTER

The remote control transmitter supplied with your CD player is designed to control all of the most commonly used features of this unit.

■ OPERATION KEYS

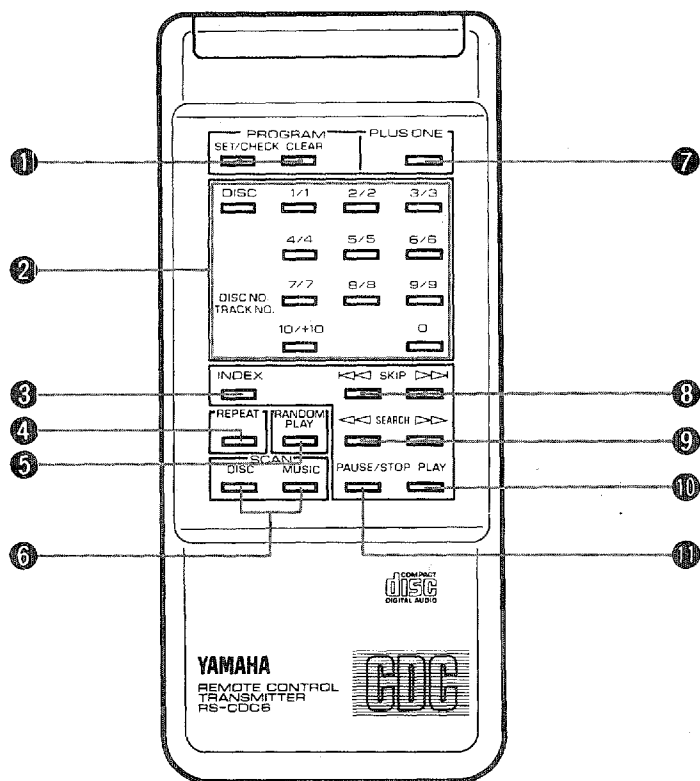

① PROGRAM keys

These keys are identical to the PROGRAM buttons on the unit.

② DISC key and DISC NO./TRACK NO. numeric keys

DISC:

Press this key first to select the disc number with the DISC NO. key.

DISC NO. (gray numerals):

These keys are used to select the disc number.

TRACK NO. (yellow numerals):

These keys are used to select the track number.

For full details on the numeric keys, refer to the Numeric Button Operation section described later.

③ INDEX key

To select the index number, first press this key, and then select the index number with the SKIP keys, or the numeric keys.

④ REPEAT key

This key is identical to the REPEAT button on the unit.

⑤ RANDOM PLAY key

This key is identical to the RANDOM PLAY button on the unit.

⑥ SCAN keys

DISC:

This key is identical to the DISC SCAN button on the unit.

MUSIC:

This key is identical to the MUSIC SCAN button on the unit.

⑦ PLUS ONE key

This key is identical to the PLUS ONE button on the unit.

⑧ SKIP keys

These keys are identical to the SKIP button on the unit.

⑨ SEARCH keys

These keys are identical to the SEARCH button on the unit.

⑩ PLAY key

This key is identical to the PLAY button on the unit.

⑪ PAUSE/STOP key

This key is identical to the PAUSE/STOP button on the unit.

■ BATTERY INSTALLATION

- ① Press the lid's locking tab down and, at the same time, pull out the battery compartment lid in the direction of the arrow.
- ② Install the batteries (size "AA", R06) with correct polarities. Follow the diagram in the compartment.
- ③ Position the bottom portion of the compartment lid in place, and push the top portion of the lid in until it clicks into place.

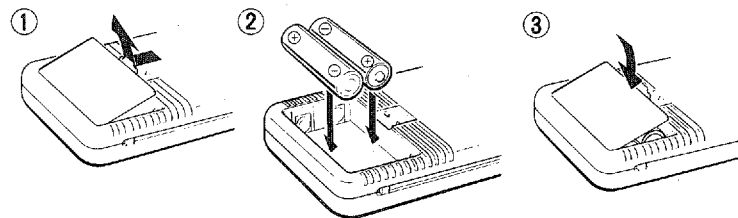

■ REMOTE CONTROL OPERATION RANGE

The remote control transmitter uses infrared light to control the unit. Therefore, to function properly there must be a clear, unobstructed path between the transmitter and the sensor on the deck. The normal operating range is about 7 meters (23 feet) and within 30 degrees perpendicular to the front panel.

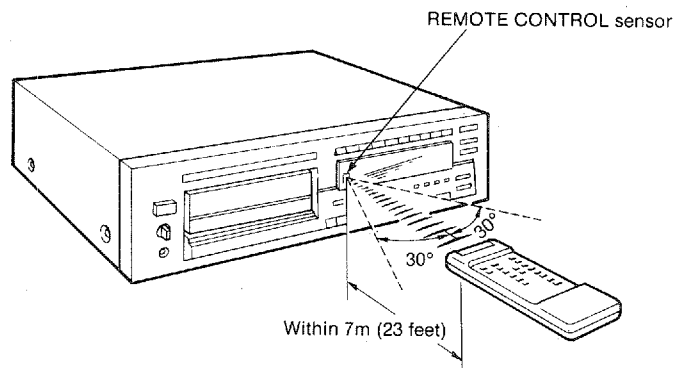

■ BATTERY REPLACEMENT

When the operating distance of the remote control noticeably decreases, the batteries are exhausted. Immediately replace the batteries with new ones.

- Replace old batteries with fresh ones. Do not use an old battery together with a new one.
- Install the same type of batteries at the same time. Do not use different kinds of batteries (carbon, alkaline, Ni-Cad, etc.) at the same time even though they are the same shape.
- There are two kinds of batteries in the market: rechargeable and non-rechargeable. Read the caution labels on the battery carefully.

■ BATTERY SAFETY

Incorrect use of the battery can cause leakage or explosion. Proper handling and use of batteries are as follows:

- When the remote control will not be used for an extended period of time, remove the batteries.
- Never disassemble, heat or throw a battery into a fire.
- Do not connect (short circuit) the (+) and (-) poles of a battery with a piece of wire, metal, etc.
- In case of leakage, thoroughly wipe off all the electrolyte from the battery compartment and install new batteries.

CONNECTIONS

- Switch OFF the power to all equipment before making any connection, and be sure to connect the cables with the correct Right and Left channel relations.
- The names given to the jacks may vary depending on the equipment. When making connections, also refer to the instruction manuals of the individual equipment.
- If this unit interferes with other equipment such as a tuner (causing noise), install this unit further away from the equipment.

To connect an amplifier or receiver

Connect the LINE OUT jacks to the CD (or AUX) jacks on the rear panel of your amplifier or receiver. If your amplifier is not equipped with these terminals, connect to the TAPE PB jacks. For details, refer to the Owner's Manual supplied with the amplifier.

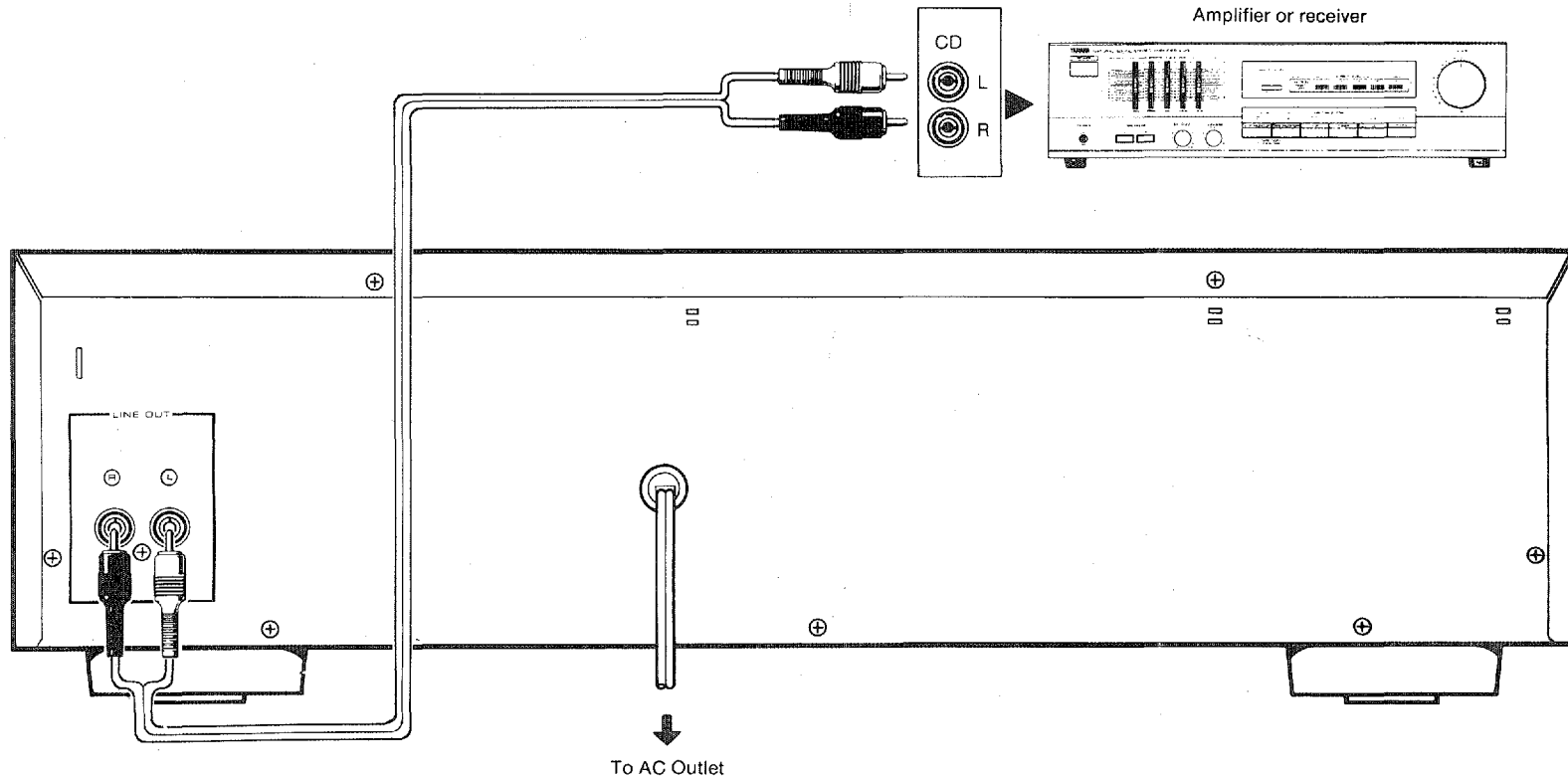

MAGAZINE LOADING

1. Press the POWER switch to turn the unit ON.
2. Insert the magazine, pushing it in until a click is heard.
Insert the discs you want to play into the magazine beforehand. Refer to "How to load discs into the magazine" described in the NOTES ON HANDLING DISCS AND MAGAZINE section.

DISC PLAY

You can load up to 10 discs into a magazine.

When 10 discs are loaded into a magazine, all tracks, from the first track on the first disc to the last track on the tenth disc can be played.

1. Place up to 10 discs into the magazine.
2. Press the POWER switch to turn the unit ON.
3. Insert the magazine.
4. Press the PLAY button.

The discs are played in sequence, from DISC 1 to 2 to 3 9 to 10, and the tracks on each disc are played from TRACK 01.

When a disc tray does not contain a disc, it is skipped, and the next disc is played. The skipped DISC NO. indicator goes off.

The unit stops at the first track on the first disc when all of the discs have been played.

- Press the PAUSE/STOP button to temporarily stop disc play. To resume play, press the PLAY button.
- Press the PAUSE/STOP button twice to completely stop play. The unit stops at the first track on the first disc.

DIRECT PLAY

■ DISC IN indicators

The DISC IN indicators correspond to the disc trays which contain a disc. When a magazine is loaded into the Magazine Slot, all of the DISC IN (1-10) indicators light. When 10 discs are loaded into the magazine, the 10 lit indicators correspond to each disc.

However, in this state, you cannot check which disc tray contains a disc when less than 10 discs are loaded into the magazines.

In this case, press the DISC SCAN button before starting play. The unit checks each disc tray, and when it finds a disc, the beginning of the disc will be played for about 10 seconds, and that DISC IN indicator remains lit. When the unit does not find a disc on a disc tray, it skips that disc tray, and that DISC IN indicator goes out. After checking all of the disc trays, the unit stops at the first track on the first disc. In this state, the disc trays which contain a disc can be noted at a glance with the DISC IN indicators.

After a Disc Scan operation, the unit only operates on discs indicated by the DISC IN indicators. Thus the operations will be speedy.

* The player also detects whether a disc is loaded into a disc tray or not with the PLAY button function. When the player does not find a disc, it skips that disc tray, but each time the player finds a disc, the entire disc will be played. When the player has detected the last disc (number 10), the DISC IN indicators finally show the corresponding discs. However, it takes a long time this way.

DIRECT DISC PLAY

To begin disc play from a desired disc, press the corresponding DISC NO. button. The DISC IN indicators allow you to note the disc tray numbers which contain discs. Play will automatically start from the first track on the selected disc.

■ Using the Remote Control Transmitter

When the DISC key is pressed, the DISC indicator starts to blink. During this period, press the DISC NO. key which corresponds to the desired disc. When a disc has been selected, the blinking DISC indicator lights steadily, and play starts from the first track on the selected disc.

DIRECT TUNE PLAY

To begin play directly from a desired tune, press the corresponding numeric button. Play will start automatically from the beginning of the selected track number.

■ Numeric Button Operation

When selecting up to the 9th tune, press the corresponding numeric button.

When selecting the 10th and later tunes, press the +10 button to set the 10's digit.

Example

To select the 25th tune:

1. Press the +10 button twice.
2. Press the 5 button.

Play starts automatically from the beginning of the 25th tune.

* When a track number which does not exist on a disc is selected, the last track on that disc will be selected and played automatically.

SEARCH OPERATION

To correct a track number consisting of one digit

Press the desired numeric button.

To correct a track number consisting of two digits

Press the desired numeric buttons.

Since it is not possible to correct only the 1's digit or only the 10's digit, first press the +10 button to set the 10's digit, and then press the desired numeric button to set the 1's digit.

* It is not possible to correct the 1's digit first. Be sure to first correct the 10's digit, and then correct the 1's digit.

■ To Play from a desired track on a specified disc

1. Press the corresponding DISC NO. button to select the desired disc.
2. Press the corresponding numeric button(s) to select the desired track on the specified disc.

Play will start from the desired track on the specified disc.

* Be sure to first select the disc number, and then select the track number. When the disc number and track number are selected in reverse order, play will start from the first track on the selected disc, not from the selected track.

SKIP SEARCH

When the unit is in play or pause mode, and you wish to move to a different track, select the new track number using the SKIP button. The selected track number will be displayed and play will begin at that track.

● To listen to the track following the tune presently being played:

Press the ►► side of the SKIP button once.

● To listen to the presently playing track once again:

Press the ◀◀ side of the SKIP button once.

● To listen to the track previous to the one presently playing:

Press the ◀◀ side of the SKIP button twice in succession.

* Tracks can be selected from only one disc. When the ◀◀ side of the SKIP button is pressed while at the first track, play will not skip to the previous disc. When the ►► side of the SKIP button is pressed while at the last track, play will not skip to the next disc. However, when the unit is in program play mode, all of the programmed tracks can be selected with SKIP the button, even when a programmed track exists on a disc other than the disc being played.

MANUAL SEARCH

■ Fast Forward Manual Search

During play or pause mode, when the ►► side of the SEARCH button is pressed, play will be advanced rapidly while this button is kept pressed.

■ Fast Reverse Manual Search

During play or pause mode, when the ◀◀ side of the SEARCH button is pressed, play will be reversed rapidly while this button is kept pressed.

- During a manual search operation, when you have found the desired part of a selection, release the SEARCH button. Play will begin from that point.
- If a manual search operation is begun from pause mode, you can search for the desired location by observing the time display alone, with no sound.
- The SEARCH buttons can only be operated on one disc. When the ►► side of the SEARCH button is kept pressed at the end of a disc, play will not advance to the next disc, but will return to the first track on the first disc, and then the unit enters stop mode. Also when the ◀◀ side of the SEARCH button is kept pressed at the beginning of a disc, play will not reverse to the previous disc, but will return to the first track on the first disc, and then the unit enters stop mode.

INDEX SEARCH

When a disc having index numbers is loaded, play can be started from a desired index number by designating it with the numeric buttons.

1. Select the desired tune with the SKIP button while in play or pause mode.
2. Press the INDEX button. The INDEX indicator starts to blink.
3. While the INDEX indicator is blinking, press the numeric button which corresponds to the desired index point.

When the index number is detected, the display shows the elapsed time, and play will start from the selected index point.

- To correct the index number, press the correct numeric button while the INDEX indicator blinks.
- The index number can be selected with the SKIP buttons instead of the numeric buttons.
- When a number exceeding the highest index number is designated, play will start from the last index point.
- If no index numbers are encoded on a disc, play will start from the beginning of the selected track.
- On some discs, the index search operation may require a slightly longer time.

Index

Indexing means that a single track has been divided into smaller divisions, and each division has been assigned an "index number". Before playing such a disc, consult the instructions of your particular disc.

SCAN FUNCTION

With this function, you can easily find a desired disc or tune.

DISC SCAN

Press this button to play approximately the first 10 seconds of each disc. Once the desired disc is found, press the PLAY button or DISC SCAN button to defeat Disc Scan mode and engage Play mode.

- During program play, the Disc Scan function cannot be carried out.

MUSIC SCAN

Press this button to play approximately the first 10 seconds of each tune on all of the discs. Once the desired tune is found, press the PLAY button or MUSIC SCAN button to defeat Music Scan mode and engage Play mode.

- During program play, the Music Scan function cannot be carried out.

RANDOM PLAY

With this function, the disc order and tune order are automatically rearranged, so that the tunes are played at random.

To carry out Random Play, press the RANDAM PLAY button when in a mode other than Program Play, Disc Scan or Music Scan.

- During Random Play, the INDEX button and PLUS ONE button cannot be operated.
- To release Random Play, press the PAUSE/STOP button twice.
- During Random Play, the Repeat function may be carried out. When REPEAT SINGLE is selected, the track being played will be repeatedly played. When REPEAT DISC is selected, all of the tracks on the disc which contains the track being played will be repeatedly played. When REPEAT FULL is selected, all of the rearranged tunes will be repeatedly played.

PROGRAM PLAY

Program Play has two types; Disc Program and Tune Program.

Disc Program play allows the desired discs to be played in the desired order.

Tune Program play allows the desired tunes to be played in the desired order. A maximum of 36 tunes, specified by disc numbers from 1 to 10 and track numbers from 1 to 99, can be programmed.

PROGRAMMING

1. Press the PAUSE/STOP button twice to set the unit into stop mode.
2. Press the PROGRAM SET/CHECK button. The PROGRAM indicator starts to blink and the program number shows P-01.
3. **To program only disc numbers without selecting tunes**
Select the disc to be played first by pressing one of the DISC NO. buttons.
The DISC display will show the selected disc number, and the TRACK display will show AL (All of the tracks).
To program tunes on all of the discs
To select the tune to be played first, press the DISC NO. button which corresponds to the disc which contains that tune, and then press the numeric button(s) which corresponds to that tune.
The DISC display will show the selected disc number and the TRACK display will show the selected track number.
4. Press the SET/CHECK button to memorize P-01.
The Program number will show P-02.
5. Select the disc and/or tune to be played next with the same procedure as in step 3.
In the same way, up to a 10-Disc Program or up to a 36-Tune Program can be stored in program memory in any desired order.

6. Press the PLAY button to start program play.

- Programming is possible only when the unit is in Stop mode.
- The REPEAT SINGLE and REPEAT FULL functions can be carried out during program play.

TO SKIP TO ANOTHER PROGRAM

During program play, play can skip to a different program.

- To listen to the program following the tune presently being played:
Press the ►► side of the SKIP button once.
- To listen to the presently playing program once again:
Press the ◀◀ side of the SKIP button once.
- To listen to the program previous to the one presently playing:
Press the ◀◀ side of the SKIP button twice in succession.
- * When the TRACK display shows AL, play can skip to a different tune on the displayed disc by pressing the SKIP button. However, when the ◀◀ side of the SKIP button is pressed twice in succession on the first track, play skips to the previous program. When the ►► side of the SKIP button is pressed on the last track, play skips to the next program.

TO RELEASE PROGRAM MODE

Press the desired DISC NO. button, and/or the numeric button which corresponds to the desired tune at any time.

Program mode will be released, and play will start from the beginning of the selected disc or selected tune.

- Even when program mode is released, the PROGRAM MEMORY indicator remains lit, to show that the program is stored in memory.

TO RETURN TO PROGRAM MODE FROM NORMAL PLAY

Press the PAUSE/STOP button twice to set the unit to Stop mode. The display shows the first program.

TO CHECK THE PROGRAMMED CONTENTS

1. Set the unit to Stop mode with the PAUSE/STOP button.
2. Press the SET/CHECK button. Each time this button is pressed, the program number, and the programmed disc and tune in that program number, are displayed in the programmed order.

TO MODIFY THE PROGRAM

1. Set the unit to Stop mode with the PAUSE/STOP button.
2. Press the SET/CHECK button to call up the program number to be changed.
3. Select a new disc number with the DISC NO. buttons and/or a new tune number with the numeric buttons.
4. Press the SET/CHECK button to memorize the new program.

TO CLEAR THE ENTIRE PROGRAM

1. Set the unit to Stop mode with the PAUSE/STOP button. The display will show P-01 and the programmed contents, and the PROGRAM indicator will light steadily.
2. Press the PROGRAM CLEAR button. The entire program contents will be cleared.
 - The entire program contents can be cleared only when the display shows the P-01 program and the PROGRAM indicator is steadily lit.
 - The program memory will not be cleared when the power is turned off or the EJECT button is pressed.

TO DELETE A PROGRAM

1. Set the unit to Stop mode with the PAUSE/STOP button.
2. Press the PROGRAM SET/CHECK button to call up the program number to be deleted. When the PROGRAM SET/CHECK button is pressed, the PROGRAM indicator will start to blink.
3. Press the PROGRAM CLEAR button. The displayed program will be cleared.
 - A program can be deleted only when the PROGRAM indicator is blinking.

REPEAT PLAY

Repeat Play has 3 function; Single Repeat, Disc Repeat, and Full Repeat.

Single Repeat:

One tune is played repeatedly.

Disc Repeat:

All of the tunes on a disc are played repeatedly.

Full Repeat:

All of the tunes on all of the discs which are loaded into the magazine are played repeatedly.

SINGLE REPEAT PLAY

Press the REPEAT button once. The REPEAT SINGLE indicator lights and the displayed tune is repeatedly played.

To release Single Repeat play, press the REPEAT button three times, until the REPEAT indicator goes off.

- If the SEARCH button is kept pressed past the tune to be repeated, the newly displayed tune is repeatedly played.
- If the SKIP button is pressed the newly displayed tune is repeatedly played.
- When the DISC SCAN or MUSIC SCAN button is pressed, Single Repeat play is defeated and the corresponding Scan mode is engaged.

■ Single Repeat for a programmed tune

During program play mode, the displayed tune can be repeatedly played with the Single Repeat function.

Press the REPEAT button once. The REPEAT SINGLE indicator lights and the displayed tune is repeatedly played.

DISC REPEAT PLAY

Press the REPEAT button twice. The REPEAT DISC indicator lights and all of the selections on the displayed disc are repeatedly played. To release Disc Repeat play, press the REPEAT button twice until the REPEAT indicator goes off.

- During program play mode, Disc Repeat cannot function. Furthermore, once a program is stored in memory (the PROGRAM MEMORY indicator is lit), Disc Repeat cannot function, even when a programmed tune is not being played.
- When the DISC SCAN or MUSIC SCAN button is pressed, Disc Repeat play is defeated, and the corresponding Scan mode is engaged.

FULL REPEAT PLAY

Press the REPEAT button three times. The REPEAT FULL indicator lights and all of the tunes on all of the discs will be played repeatedly. To release Full Repeat play, press the REPEAT button once.

- When the DISC SCAN or MUSIC SCAN button is pressed, Full Repeat play is defeated and the corresponding Scan mode is engaged.

■ Full Repeat Play for a program

During program play mode, all of a program can be repeatedly played with the Full Repeat function.

Press the REPEAT button three times. The REPEAT FULL indicator lights and all of the programmed discs and/or tunes are repeatedly played.

PLUS ONE PLAY

With the Plus One function, a desired tune will be played after playing the current tune.

1. Press the PLUS ONE button during play.
The PLUS ONE indicator starts to blink, and the current disc number and track number disappear.
 2. During this period, select the tune to be inserted. Press the DISC NO. button, and then the numeric button which corresponds to the desired tune.
 3. Press the PLUS ONE button again. The blinking PLUS ONE indicator lights steadily.
After playing the current tune, the selected tune will be played. When the selected tune has been played, play will resume with the next tune located on the original disc.
- The PLUS ONE button functions even during program play or repeat play. During program play, play will resume with the next programmed tune after playing the selected tune.
During repeat play, the corresponding repeat play will resume after playing the selected tune.

TIMER PLAY

Timer play can be performed when the player is used with a commercially available audio timer.

1. Set the amplifier to play the compact disc player.
 2. Turn on the power and insert the magazine.
 3. Set the timer to the time at which you wish play to begin.
 4. At the time set on the timer, play will begin from the first tune. When the magazine contains more than 1 disc, play will begin from the first tune on the first disc.
When a program has been stored in memory, play will begin from the first programmed tune.
- Be sure to set the output volume of the amplifier to the desired level beforehand.

MEMORY BACKUP

With the built-in capacitor, the program memory is retained even when the power is turned OFF. However, when this unit is not used for a few days, the retained memory is sometimes erased.

SPECIFICATIONS

AUDIO SECTION

Frequency Response	DC 5 Hz — 20 kHz, ± 0.5 dB
De-Emphasis Equalization	± 0.5 dB
Harmonic Distortion + Noise	Less than 0.008% (1 kHz)
S/N Ratio	100 dB
Dynamic Range	More than 96 dB
Wow & Flutter	Unmeasurable
Channel Separation	More than 80 dB (1 kHz)
Output Voltage	2V
Output Impedance	2.2 k-ohms
Headphone Output	200 mV/150 ohms

INTERNAL SYSTEM

Optical Pick-up	3-beam laser
Error Correction System	CIRC
D/A Conversion	16-bit linear
Filter	Hi-bit quadruple oversampling digital filter and 3rd order new active filter

GENERAL

Power Requirements	AC 120V, 60 Hz
Power Consumption	18W
Dimensions (W x H x D)	435 x 126 x 356.5 mm (17-1/8" x 4-3/4" x 16-7/16")
Weight	7.2 kg (31 lbs. 5 oz.)
Accessories	Pin plug cord Remote control transmitter (RS-CDC6) Batteries (size "AA", R06)

Note that all specifications are subject to change without notice.

TROUBLESHOOTING

If your unit fails to operate normally, check the following points to determine whether the fault can be corrected by the simple measures suggested. If it cannot, or if the fault is not listed in the SYMPTOM column, disconnect the player's power cord and contact your dealer or service center for help.

SYMPTOM	CAUSE	REMEDY
The player fails to turn on when the POWER switch is pressed.	The power cord is not plugged in or completely inserted.	Firmly plug in the power cord.
Magazine is not expelled when EJECT button is pressed.	Improper insertion of a power plug.	Insert the power plug tightly into the AC outlet.
The DISC indicator does not light.	The disc is damaged.	Check the disc carefully and replace it if necessary.
	There is moisture on the laser pickup.	Wait 20 to 30 minutes after turning the unit on before trying to play a disc.
Play does not begin.	The disc is loaded with its label surface facing up.	Reload the disc with the label side down.
	The disc is dirty.	Clean the disc.
Playback is delayed, or begins at the wrong place.	The disc may be scratched or damaged.	Check the disc carefully and replace it if necessary.
No sound.	Improper output cable connections.	Connect the cables properly. If the problem persists, the cables may be defective.
	Improper amplifier operation.	Set the amplifier controls to the correct input selection.
Sound "skips".	The player is subjected to vibrations or shock.	Relocate the player.
	The disc is dirty.	Clean the disc.
Sound "hums".	Improper cable connections.	Firmly connect the audio plugs. If the problem persists the cables may be defective.
Noise in the tuner.	The tuner is too close to the player.	Move the tuner away from the player.
Noise from within the disc tray.	The disc may be eccentric.	Replace the disc.

YAMAHA

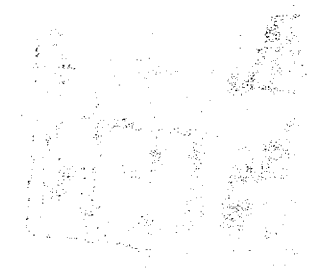

VF49340-0

YAMAHA CORPORATION
10-1, Nakazawa-cho, Hamamatsu, 430 Japan

BWgg.b  Printed in Japan